

Innovative Mosquito Trap

M  **OSCLEAN**

Innovative Mosquito Trap

World's Best UV LED + CO₂



Innovative Mosquito Trap

Specification



Product name	MOSCLEAN
Color	Black, White
Mode of action	Dehydration
Size	200 (Ø) mm × 232 (H) mm
Color	Black (or white)
Weight	359g
Light source	365nm LED 6EA
Noise	< 28.3 dBA
Power consumption	12V 0.22A, 4W(Max)
Power	DC 12V SMPS, 100~240V
Installation	Hanging hook / Stand alone

Innovative Mosquito Trap

Distinctive Features

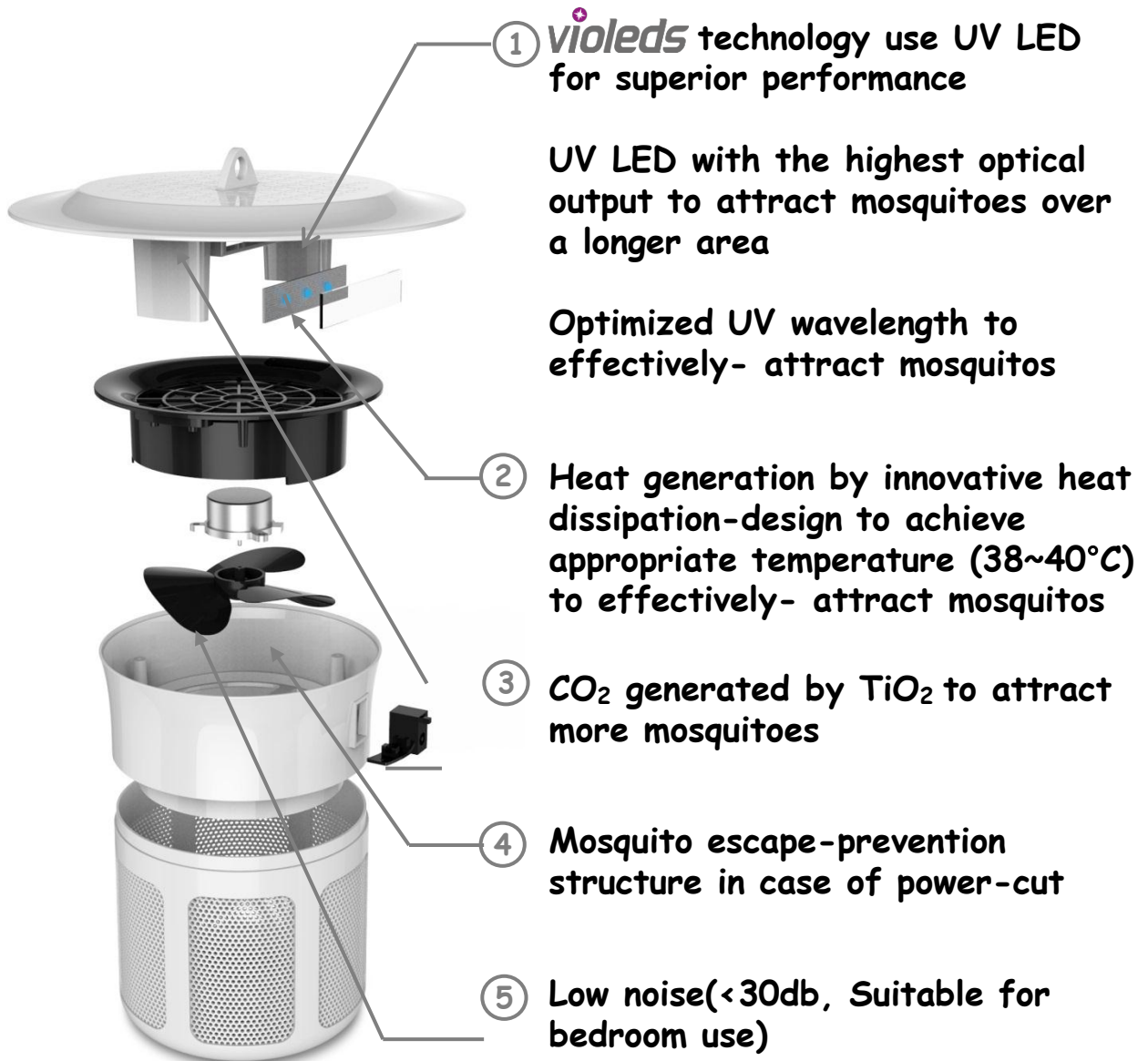

Innovative Mosquito Trap

Distinctive Features

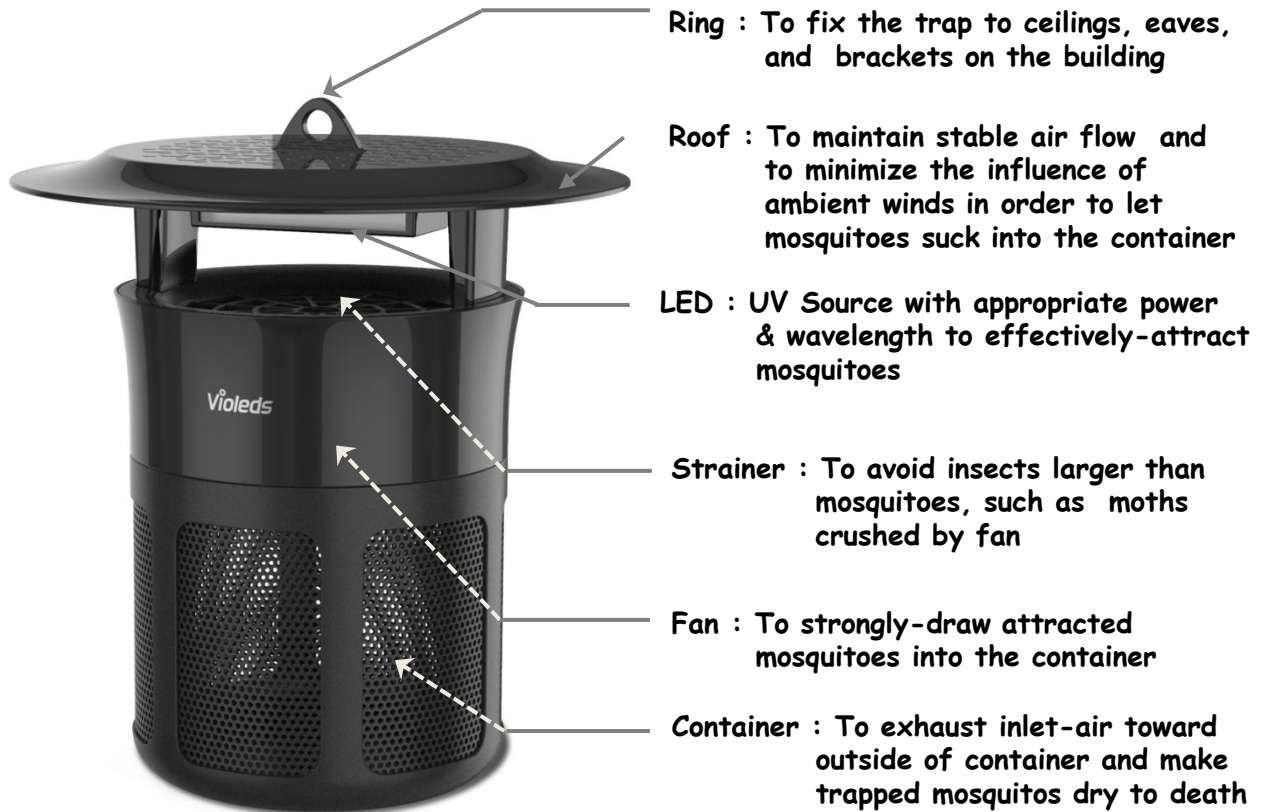

- ❖ Low power consumption & highly-efficient UV LED
- ❖ No chemicals, no gas, and no refill
- ❖ Eco-friendly light source
- ❖ Easy to set up & easy to use
- ❖ Highly competitive capture performance versus mercury lamp
- ❖ Quiet operation without noise by electronic spark
- ❖ No scattering debris in the air









Innovative Mosquito Trap

Packaging

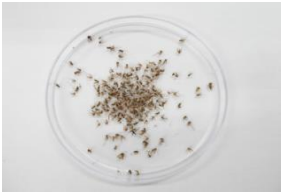

Innovative Mosquito Trap

Performance

Products	MOSCLEAN	Comp1	Comp2
Image			
Size (mm)	Φ200 × H232	Φ250 × H300	Φ264 × H310
Power Consumption	2.64 Watts	30 Watts	15 Watts
Light Source	UV LED 6ea	4W BL 2ea	4.5W UV Lamp
Fan (mm)	DC 12V Fan(Φ90)	220V AC Fan(Φ127)	DC 18V Fan (Φ105)
Coverage (m ²)	60	60	60
Power Source	100~240 V / 60Hz	220 V / 60Hz	220~240 V / 60Hz
Capturing Test Case1			No mosquito captured
Capturing Test Case2			No mosquito captured
Capturing Test Case3			No mosquito captured

Innovative Mosquito Trap

Multiple use options

Bedroom



Kitchen



Bathroom



Living Room



Garden/Deck

