



Professional Stadium Lights

LR580 Series

- *OSRAM LED Chips;
- *Super narrow beam angles to 6 degree;
- *Air flow 4D heat dissipation technology;
- *With a laser pointer that installs in 2 seconds;
- *Applicable for FIFA/ UEFA stadiums;

Lumi  **ne**
SMART LIGHTING SOLUTIONS



LR580-840W / 1020W / 1280W / 1500W



IP66 Rating



IP67 Rating



Wind Resistance
60m/s



Adjustable Angle

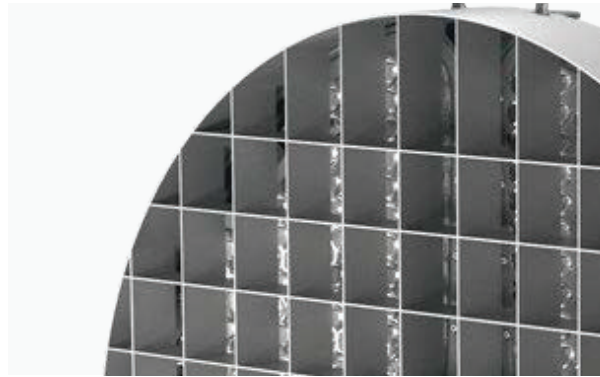
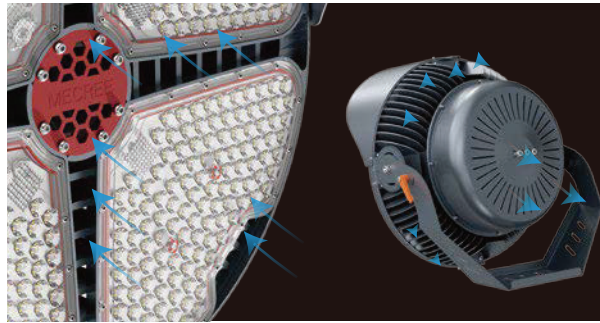

Optics

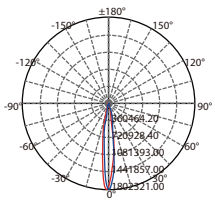

6°

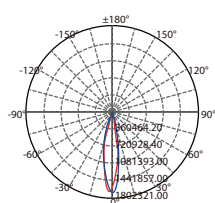

8°

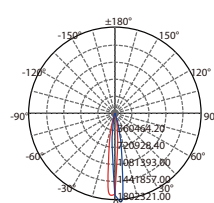

12°

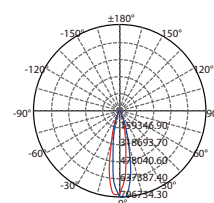

25°

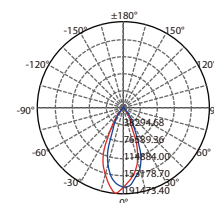

50°

Specification

ITEM	LED	Power Supply	Input Voltage
LR580-840W /1020W /1280W /1500W	Lumileds/OSRAM	Meanwell, Inventronics, Custom	100-277V AC /200-480V AC 50/60Hz
System Wattage	Beam Angle	CCT	CRI
840W/1020W/1280W/1500W	6°/8°/12°/25°/50°	3000K/4000K/5000K /5700K/6500K	70/80/90+
Lifespan	Surge protection device standard	Operating Temperature	IP/IK Rating
100000H	10KV /20KV	-40°C-+50°C	IP66/IP67/IK10
Dimming	EPA	Color	LUMEN
0-10V/DALI/DMX	LR580 840W 5.72 sq.ft LR580 1020W 5.72 sq.ft LR580 1280W 5.72 sq.ft LR580 1500W 6.13 sq.ft	Gray (standard) Black (Chosen)	LR580 840W 137760 LM LR580 1020W 166770 LM LR580 1280W 208640 LM LR580 1500W 241500 LM

840W~1500W

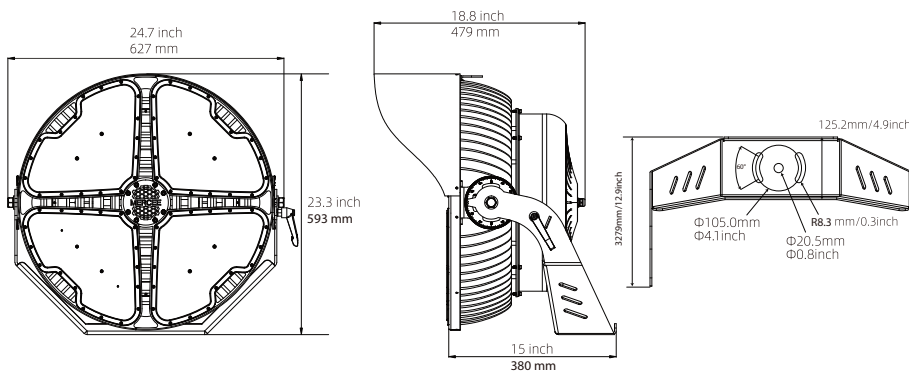

840W Weight: 33 KG
Remove driver: 27.8 KG

1020W Weight: 33 KG
Remove driver: 27.8 KG

1280W Weight: 35 KG
Remove driver: 27.8 KG

1500W Weight: 39 KG
Remove driver: 27.8 KG

180-528V AC high voltage power supply design, can replace the traditional lamp directly.

R580

